



**SOLENOID OPERATED
DIRECTIONAL CONTROL VALVE
DE 06 (CETOP 03)**

ENGINEERING

1

Ref. No. P09321
Release 04/2009

Description

Direct solenoid operated, spool type, mounting on ISO 4401-03-02.
Five chamber body and spool design provides low-pressure drop, with maximum performance.
Balanced spool design ensures proper shifting force for maximum reliability and long life.
All spools and bodies are interchangeable, simplifying maintenance.
Wet pin DC solenoids ensure better heat dissipation, quieter operation, there by increasing solenoid life.
Moulded solenoid coils eliminate moisture problems and ingress of dust.
Plug-in-coils for ease of maintenance.
Indicator lights are a standard feature.

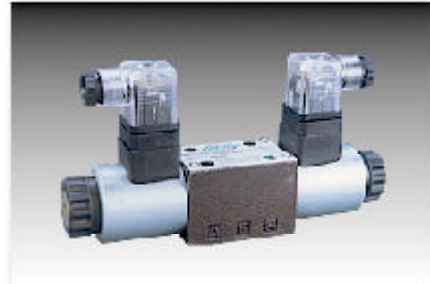

Section

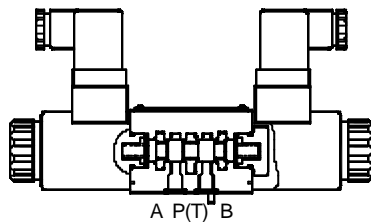

Hydraulic Symbol

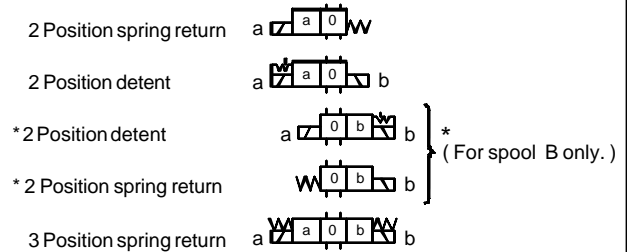

Unit dimension

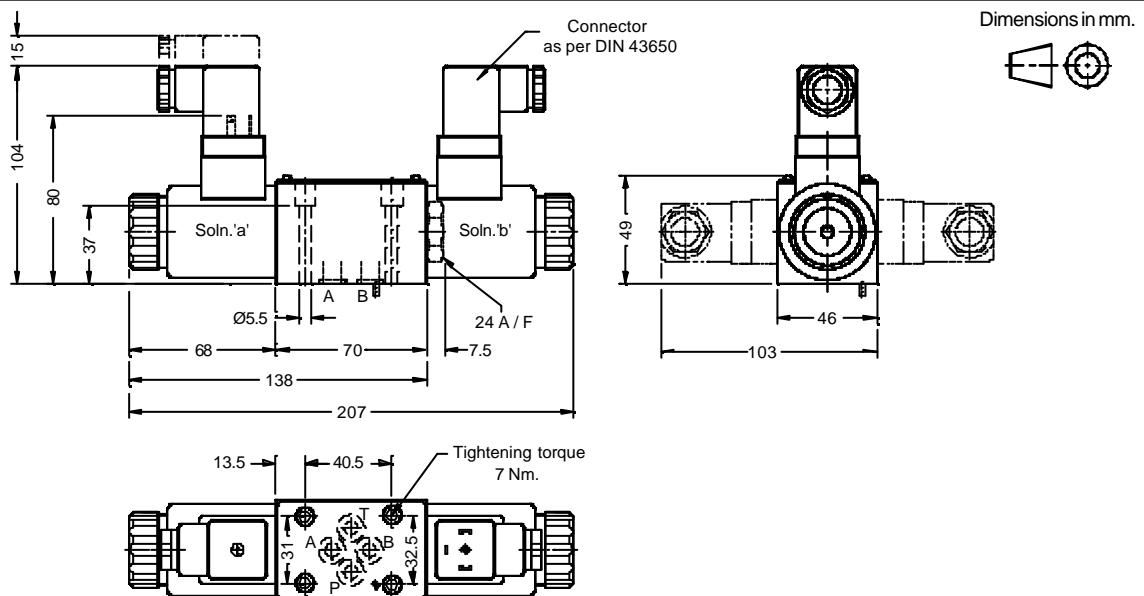

Polyhydron Pvt. Ltd.
78-80, Machhe Industrial Estate,
Machhe, Belgaum - 590 014. INDIA.

Phone : +91-(0)831-2411001
Fax : +91-(0)831-2411002
E-mail : polyhydron@vsnl.com
Website : www.polyhydron.com



**SOLENOID OPERATED
DIRECTIONAL CONTROL VALVE
DE 06 (CETOP 03)**

ENGINEERING

2

Ref. No. P09321

Technical specification

Hydraulic :

Construction	Spool type.
Mounting	Subplate body as per ISO 4401-03-02.
Mounting position	Optional.
Operating Pressure	For ports P, A, B315 bar port T150 bar (For spool type A & B, port T to be used as drain line, if the operating pressure exceeds 150 bar.)
Nominal flow handling capacity	63 lpm.
Max. flow handling capacity	Refer graph.
Flow direction	Refer spool chart.
Hydraulic medium	Mineral oil.
Viscosity range	10 to 380 cSt.
Working temperature range	-20 °C to +70 °C.
Fluid cleanliness requirement	As per ISO code 16/13 or better.
Weight	Valve with Single solenoid - 1.2 kg. Valve with Double solenoid - 1.8 kg.

Electrical :

D.C.Voltage	12 V, 24 V
A.C.Voltage	110 V, 220 V at 50 Hz
Power requirement	30 W
Duty cycle	Continuous
Switching time (ON)	40 ms
(OFF)	30 ms
Max. ambient temperature	50 °C
Max. coil temperature	100 °C
Max. switching frequency	15000 / hour
Protection	IP 65

Note :

AC solenoid coil is basically a DC coil with built-in rectifier.



**SOLENOID OPERATED
DIRECTIONAL CONTROL VALVE
DE 06 (CETOP 03)**

ENGINEERING

3

Ref. No. P09321

Performance curves

Oil Used : ISO VG 68, Test temp : 50 °C.

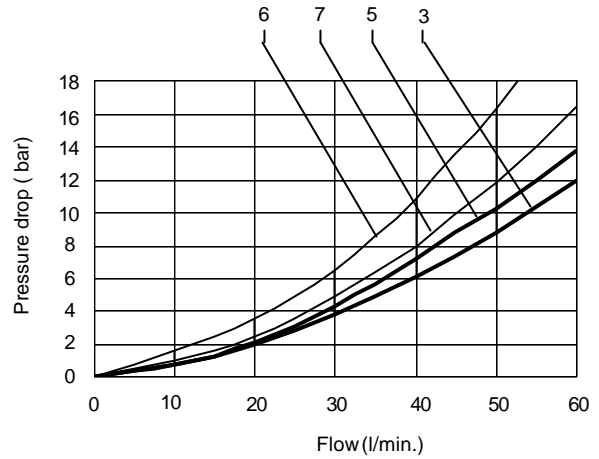
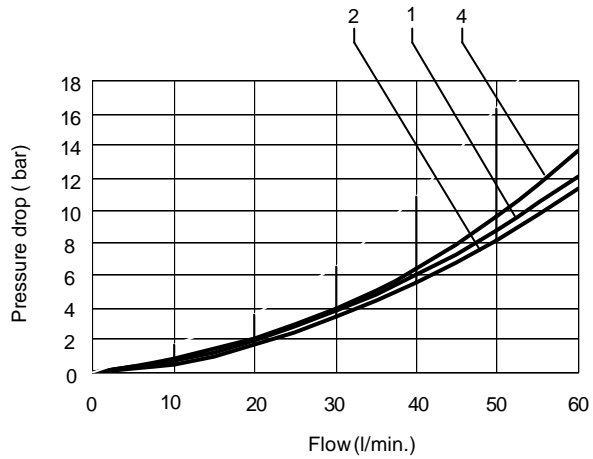

Table showing the relation between the spool type, direction of flow and curve in the above graph to be referred to.

Spool type	Direction of Flow / Curve No.				
	P to A	P to B	A to T	B to T	P to T
A	4	4	--	--	--
B	4	4	--	--	--
C	4	4	5	2	--
D	4	4	5	2	--
E	3	3	5	5	--
F	1	3	1	3	--
G	6	6	6	6	7
H	1	1	2	2	4
J	3	3	2	2	--
L	3	3	2	5	--
M	1	1	5	5	--
P	3	1	3	1	--



**SOLENOID OPERATED
DIRECTIONAL CONTROL VALVE
DE 06 (CETOP 03)**

ENGINEERING

4

Ref. No. P09321

Ordering code

4 DE 06 E S A220 A 01

Service port	3
	4

Directional control valve
Solenoid operated

Size 06

Spool type
Refer chart

Spring return	S
Detent (For 2 position valve only)	D

Design code subject to change. Installation dimensions remain same. for design code 01 thru 09.

Option for converting 3 position valve to 2 position

A	Solenoid at 'A' only.
B	Solenoid at 'B' only.
Omit for standard valve	

Coil voltage	
D12	DC 12V
D24	DC 24V
A110	AC 110V, 50 Hz.
A220	AC 220V, 50 Hz.

Type	Symbol	Crossover	Type	Symbol	Crossover
	a 0 b A B P T			a 0 b A B P T	
A			J		
B			L		
C			M		
D			P		
E			Q		
F			U		
G			V		
H			W		

All rights reserved.
Subject to revision.



SOLENOID OPERATED
DIRECTIONAL CONTROL VALVE
DE 06 (CETOP 03)

ENGINEERING

Ref. No. P09321

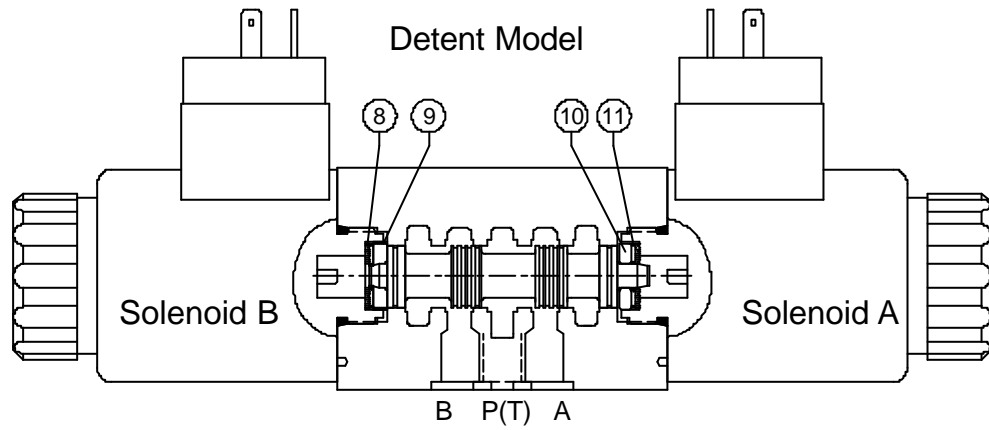
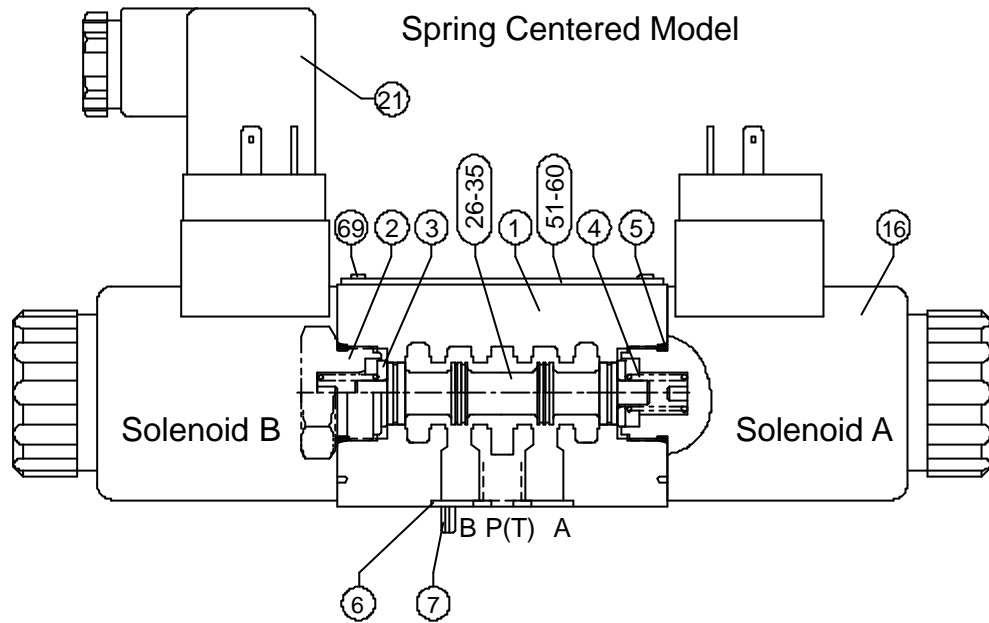



**SOLENOID OPERATED
DIRECTIONAL CONTROL VALVE
DE 06 (CETOP 03)**

ENGINEERING

Ref. No. P09321

Sl.No.	Description	Part No.	Size	Qty
1	Body	30201		01
2	End Plug	30202		01
3	Spring Pad	30203		02
4	Spring	30204		02
5	O'ring (Nitrile 90 Shore A)	30205	Ø17.17 x 1.7Ø	01
6	O'ring (Nitrile 99 Shore A)	30206	Ø9.25 x 1.75	04
7	Spring Dowel	00031	Ø3 x 10 L	01
8	Spacer	30208		01
9	Spring Retainer	30209		01
10	Stopper	30210		01
11	Detent Spring	30211		01
16	Soln. Assly.(12V DC)	30216	PGZ45-12V DC	01
17	Soln. Assly.(24V DC)	30217	PGZ45-24V DC	01
18	Soln. Assly.(110V AC-50 Hz)	30218	PWZ45-110V AC	01
19	Soln. Assly.(220V AC-50 Hz)	30219	PWZ45-220V AC	01
21	Connector	30221	DIN 43650-12VDC	01
22	Connector	30222	DIN 43650-24VDC	01
23	Connector	30223	DIN 43650-110VAC	01
24	Connector	30224	DIN 43650-220VAC	01
26	Soln.Coil(12V DC)	30226	PGZ45-12VDC	
27	Soln.Coil(24V DC)	30227	PGZ45-24V DC	
28	Soln.Coil(110V AC-50 Hz)	30228	PWZ45-110V AC	
29	Soln.Coil(220V AC-50 Hz)	30229	PWZ45-220V AC	
31	Spool A & B	30231		01
32	Spool C	30232		01
33	Spool D	30233		01
34	Spool E	30234		01
35	Spool F & P	30235		01
36	Spool G	30236		01

Sl.No.	Description	Part No.	Size	Qty
37	Spool H	30237		01
38	Spool J	30238		01
39	Spool L	30239		01
40	Spool M	30240		01
41	Spool Q	30241		01
45	Spool T	30245		01
46	Spool U	30246		01
47	Spool V	30247		01
49	Spool S1	30249		01
51	Label Common	30251		01
53	Label C & D (Detent)	30253		01
54	Label C & D	30254		01
55	Label E	30255		01
56	Label F	30256		01
57	Label G	30257		01
58	Label H	30258		01
59	Label J	30259		01
60	Label P	30260		01
68	Packing Box	30268	210 x 115 x 50	01
69	CRPH Screw	Ø0140	M3 x 6L	02
70	Interface Pad	30270	Size 06	01

Note : * Recommended seal kit. * & # Recommended spare kit.
While ordering the individual spares / spare kit / seal kit, give part no. and complete details of model code as on the label.