



PILOT OPERATED PRESSURE REDUCING VALVE PPM 06K

ENGINEERING

1

Ref. No. D 23100 B
Release 01/2004

Description

Two stage spool type Reducing valve cartridge

Two options for pressure adjustment,

- With set screw and lock nut.
- With hand knob and lock nut.



Section

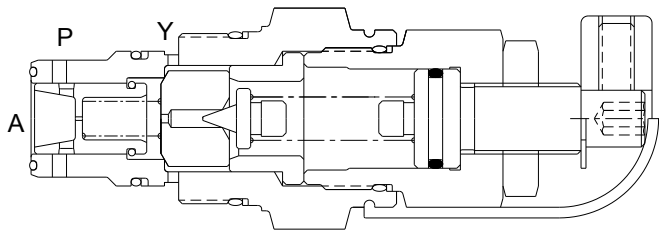

Hydraulic Symbol

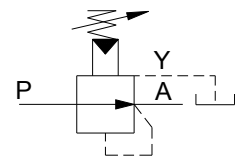

Unit dimension

Threaded cartridge and cavity details

Dimensions in mm.

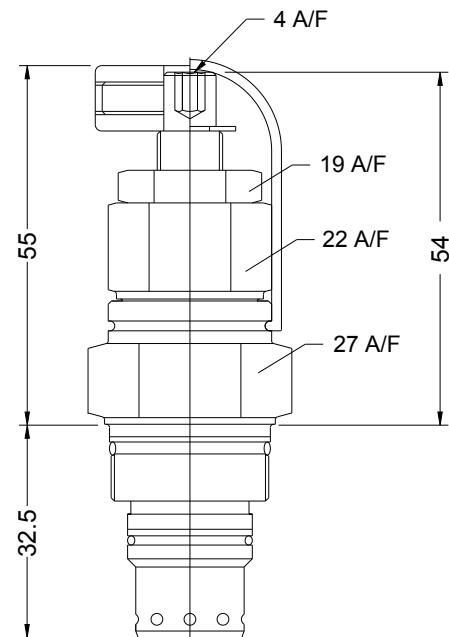
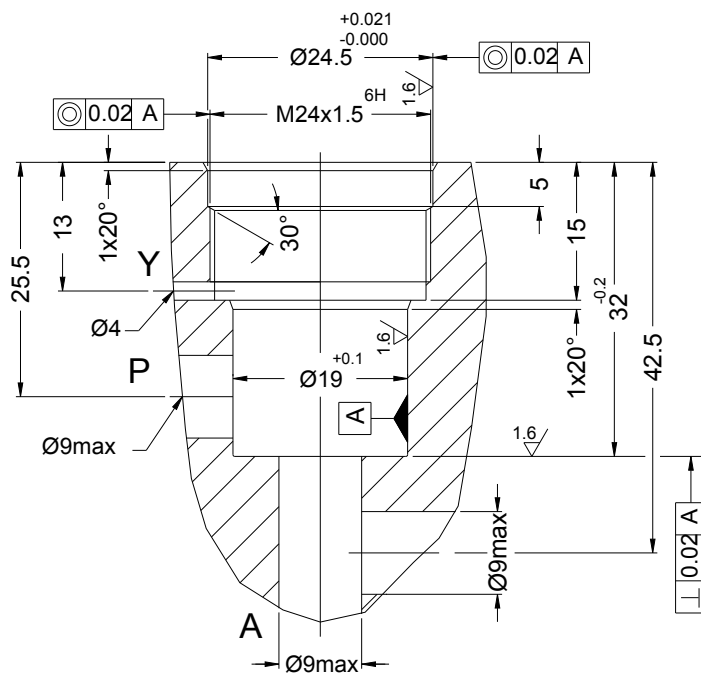
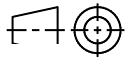

Polyhydron Pvt. Ltd.
78-80, Machhe Industrial Estate,
Machhe, Belgaum - 590 014. INDIA.

Phone : +91-(0)831-2411001
Fax : +91-(0)831-2411002
E-mail : polyhydron@vsnl.com
Website : www.polyhydron.com



**PILOT OPERATED
PRESSURE REDUCING VALVE
PPM 06K**

ENGINEERING

2

Ref. No. D 23100 B

Technical specification

Construction	Pilot Operated Spool Type
Mounting	Threaded Cartridge, Factory standard.
Mounting position	Optional
Flow direction	From port P to A
Operating pressure	For port P 315 bar
	For port A 200 bar
	For port Y 1 bar
Hydraulic medium	Mineral oil
Viscosity range	10 Cst to 380 Cst.
Fluid temperature range	-20 °C to +100 °C.
Fluid cleanliness requirement	As per ISO 16/13
Maximum flow handling capacity	30 lpm
Mass	0.2 kg.

Ordering code

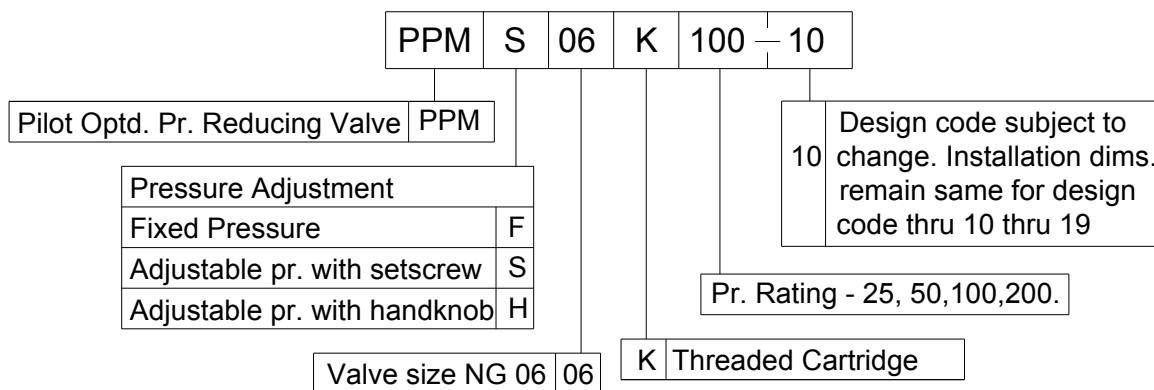



**PILOT OPERATED
PRESSURE REDUCING VALVE
PPM 06K**

SERVICE

3

Ref. No. D 23100 B

Sectional view & Part details

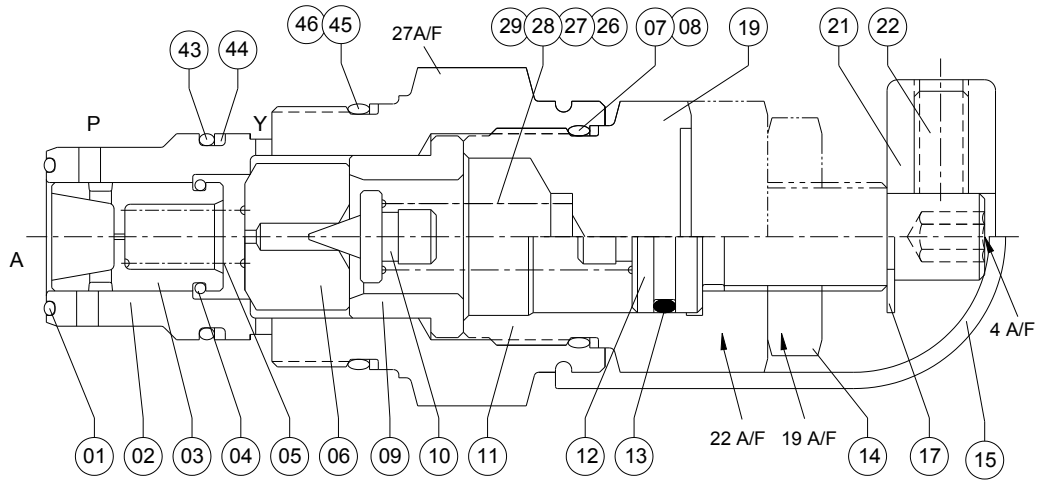

Sl no	Description	Part No	Qty
* 1	O'Ring Ø12.5 id x 1 csd	23101	1
2	Main Bush		1
3	Main Poppet		1
4	Spring ring Ø8 id X 1 csd		1
5	Spring		1
6	Pilot valve seat		1
* 7	O'Ring 17.5 ID x 1.5 CSD	23107	2
8	Back up ring 18 x 20.5 x 1 th	23108	2
9	Spacer		1
10	Pilot Poppet		1
11	Spring Casing		1
12	Adjusting screw		1
* 13	O'Ring Ø10.5 ID x 1.5 CSD	23113	1
14	Check Nut		1
15	Rubber Cap		1

Sl no	Description	Part No	Qty
17	Circlip `C' Type Ø6 Nominal	23117	1
19	Plug (Fixed Pr.)		1
21	Hand knob		1
22	Grub screw		2
# 26	Spring 25 bar	23126	1
# 27	" 50 bar	23127	1
# 28	" 100 bar	23128	1
# 29	" 200 bar	23129	1
43	O Ring (16 id x 1.5 csd)		1
44	Backup Ring (16 x 18.98 x 1)		1
45	O Ring (21 id x 1.5 csd)		1
46	Backup Ring (21 x 24.48 x 1)		1

Note : * Recommended seal kit. * & # Recommended spare kit.

While ordering the individual spares / spare kit / seal kit, give part no. and complete details of model code as on the label.